

guarantee

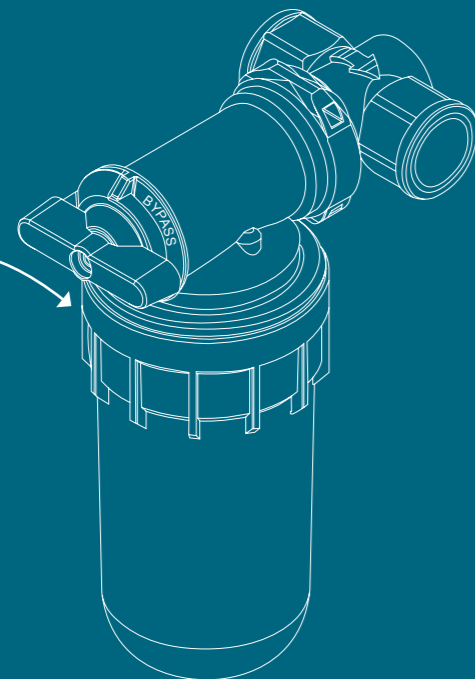

Scan the QR code on your product to extend your guarantee to 3 years.



tips & tricks



Connect only to the cold water pipe. Fit either just downstream from the water meter; or just upstream from the boiler.



Always install the device(s) in a vertical position and make sure your handle is turned to "OPEN".



Duo kit: fit the filter upstream of the polyphosphate device.



Watch our installation videos online:
limesolutions.eu/installation-manual

meet lime

who is Lime

Behind lime stands a passionate team on a mission. We want to support you in being the best do-it-yourself master you can be. With a combined experience in the water treatment industry of over 40 years, the choice for our first product was evident. We're proud to present to you: our DIY kit designed to provide you with the optimum protection for your plumbing system. No more damage caused by limescale and corrosion. Get to know our limescale and filter devices!

diy Kits

The lime do it yourself kits are made based upon one principal thought: strong, qualitative products that are simple to install by a non-professional. You don't have to search for the right connectors, compression rings or couplings for hours. It's all just right there, in our kit.

Do you have the feeling you're still missing something? Reach out and we'll help you. Have fun installing!



user manual get started!

let's get to work

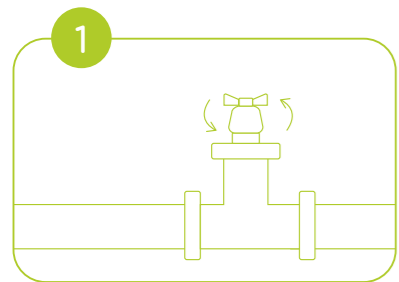

Shut off the water supply

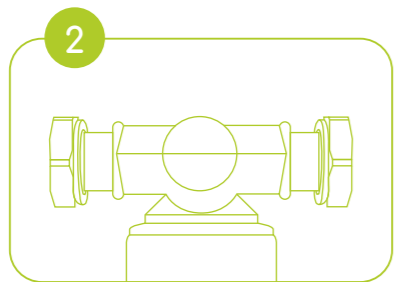

Take the device(s) with the couplings (B) and insert the seals

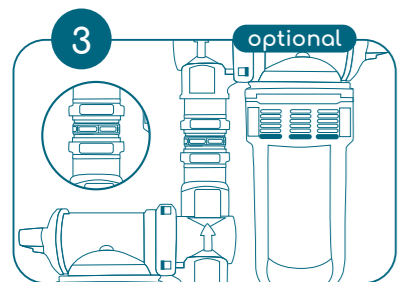

Optional - If you have a duo kit: connect both devices with the spacer (C)

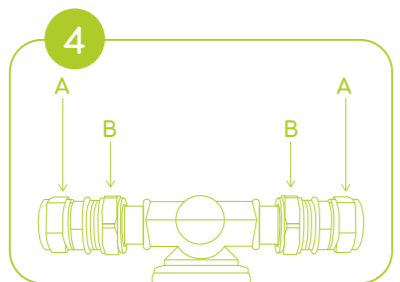

Then mount connectors (A) on the couplings (B)*

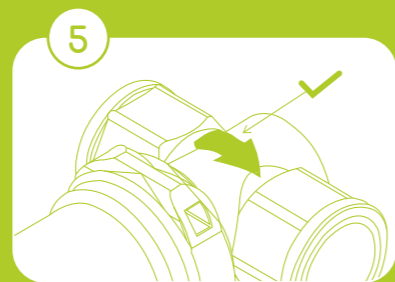

Make sure the water flow follows the direction of the arrow on your device(s)

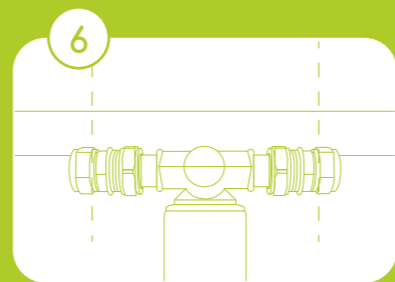

Take this combination and hold it against the pipe where you want to install - mark the place where the pipe is to be cut and cut out**

*Don't forget to put the seals in the couplings
**for more concrete info regarding the different connection pieces, see installation videos on our website
For connection with flexible pipe: use our handy bracket to mount your device on the wall

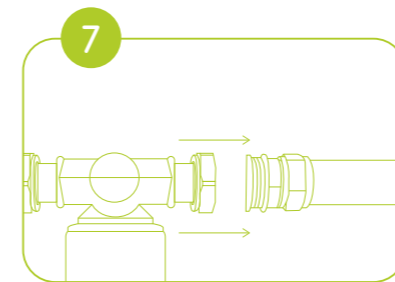

Disconnect the connectors (A) from your device and slide separately over the tubes

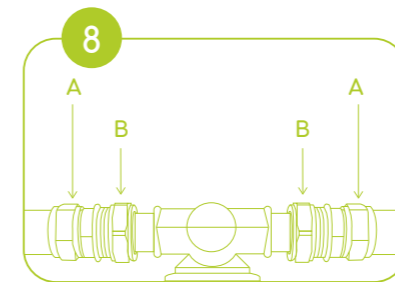

Connect connectors (A) to couplings (B)* and fix the connectors (A) firmly

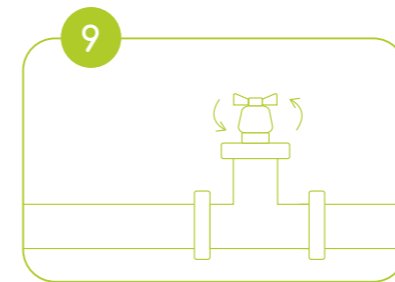

Turn on the water tap again and check for any leaks. Tighten where necessary.



Replacing your cartridge

- 1 Turn the handle to "BYPASS"
- 2 Open the reservoir
- 3 Replace the cartridge or filter
- 4 Close the reservoir hand-tight. Do not use any tools.
- 5 Turn the handle to "OPEN"

